

COMPONENTS

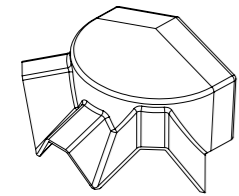

CRS 9240
Skypod 3-bar top cap

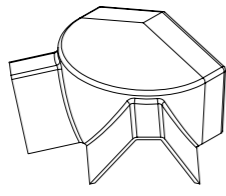

CRS 9241
Skypod 2-bar top cap

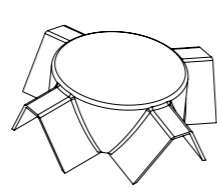

CRS 9242
Skypod SQ spider top cap

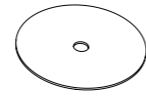

CRS 9423
Skypod SQ sealing plate

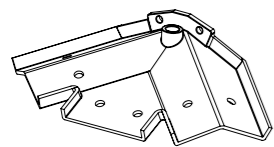
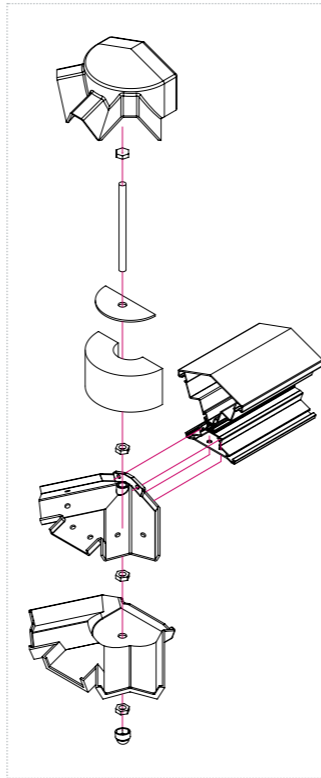

CRS 9521A
Skypod 3-bar spider bracket

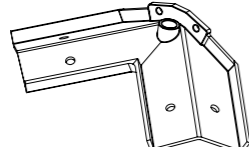

CRS 9522A
Skypod 2-bar spider bracket

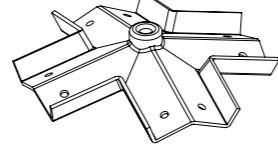

CRS 9523A
Skypod SQ spider bracket

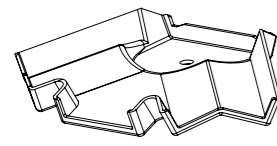

CRS 9248
Skypod 3-bar bottom cap

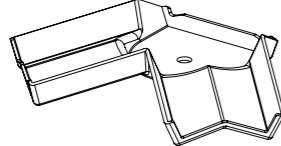

CRS 9249
Skypod 2-bar bottom cap

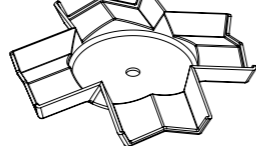

CRS 9250
Skypod SQ spider bottom cap

Spider bracket screws
CRS 8626S
CRS 9626S



CRS 9421
Skypod foam bung



CRS 9422A
Skypod foam bung sealing plate

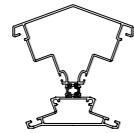

CRS 9520A
Skypod ridge body



CRS 8625
Single variable support stud

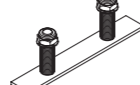

CRS 8624
Double variable support stud



CRS 9200
skypod screw cap covers

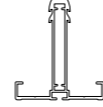

CRS 8501A
Standard rafter



CRS 8016
25mm rafter top cap



CRS 8011
Rafter bottom cap

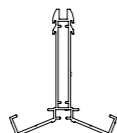

CRS 8502A
Edwardian hip



CRS 8017
25mm Edwardian hip top cap

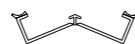

CRS 8012
Hip bottom cap



CRS 9550A
skypod Eaves 20°



CRS 9552A
skypod Thermally broken eaves beam 20°



CRS 9934
skypod Boss kit



CRS 8053
Eaves beam seal



CRS 8024
24/25mm ridge glazing trim



CRS 8654
90° eaves beam cleat



CRS 8201
skypod Rafter/Hip end cap



CRS 9201
skypod Rafter end cap

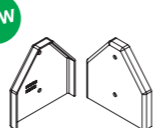

CRS 9202
skypod Hip rafter end cap

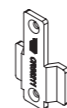

CRS 8211
Glazing stop screws (CRS 8682 Glazing stop screws)



CRS 9611S
Stainless steel glazing stop (CRS 8682 Glazing stop screws)

ASSEMBLIES

Ridge assembly

Powder-coated aluminium, thermally broken

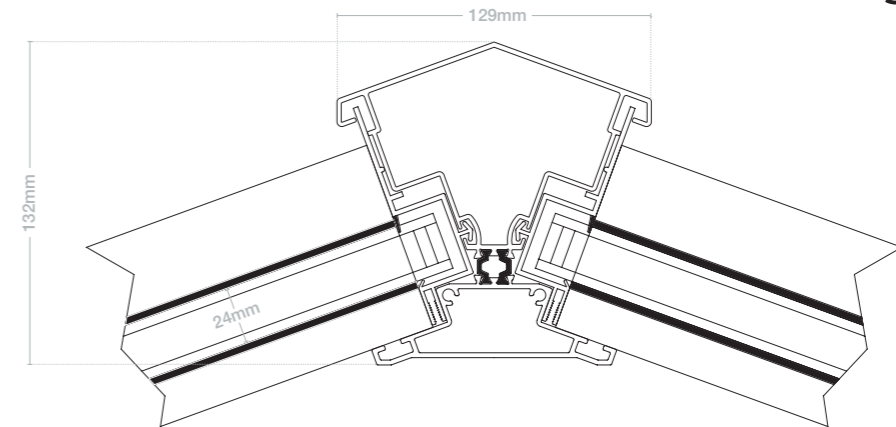

Hip assembly

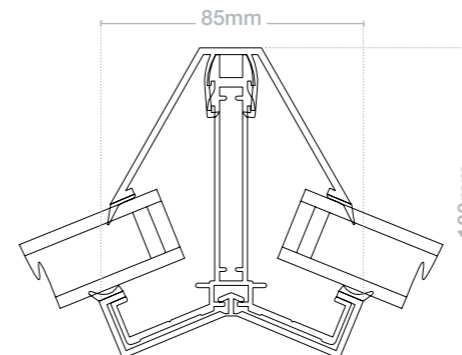

Ring beam on kerb assembly

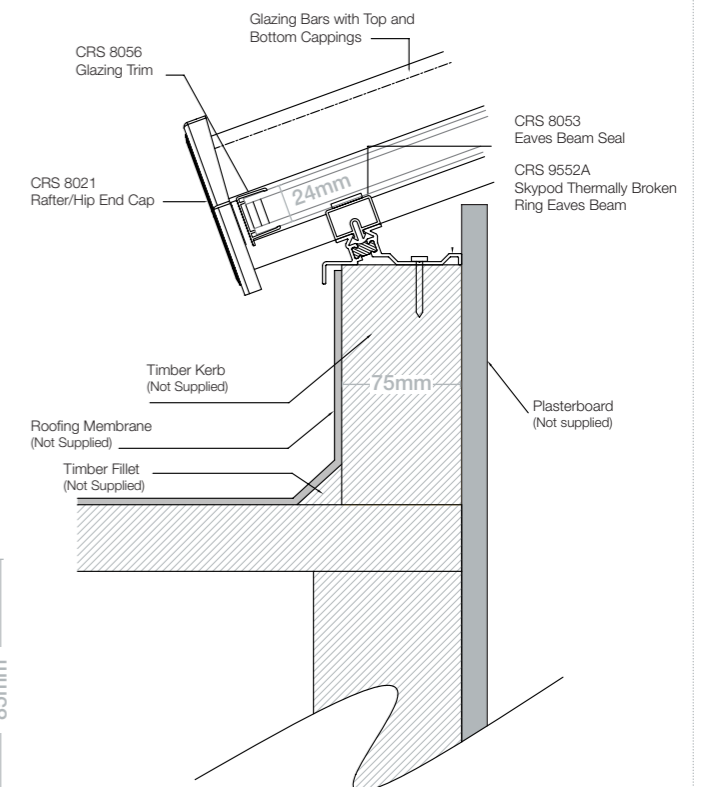

Rafter assembly

